

# Varimec™

Round or square caps •  
variable total and above recess heights



## DISTINCTIVE FEATURES

Round or square cap: 5.2 mm, 7.8 mm, 11.6 mm

10 total height options 10.4 - 22.5 mm

8 above recess height options 2.4 - 6.4 mm



SWITCH SPECIFICATIONS : see Multimec® 3 series.

### 3E+5.2

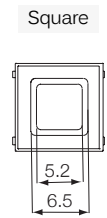
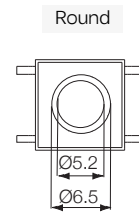
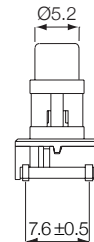
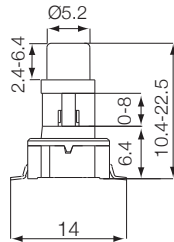

### 3E+7.8

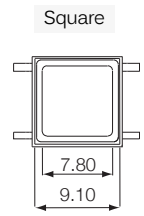
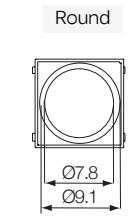
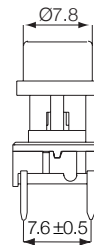
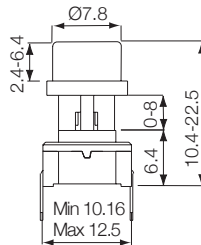

### 3E+11.6

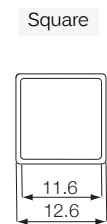
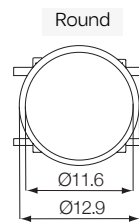
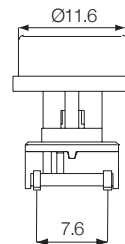
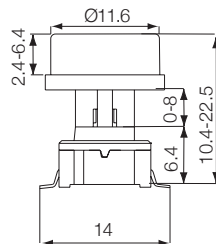

## THE CONCEPT

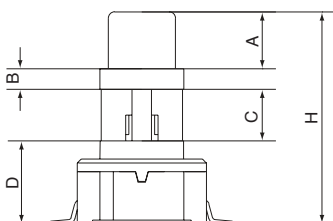

- H= Overall heights from 10.4-22.5
- A= Variable height from 2.4 to 6.4  
H has to exceed A with min. 8.0
- B= Fixed recess 1.6
- D= Fixed switch 6.4
- C= Variable from 0-8.1  
C=H-A-B-D
- All measurements in mm

The company reserves the right to change specifications without notice. All tolerance if not otherwise specified ±0.2mm.

# Varimec™

Round or square caps •  
variable total and above recess heights



## BUILD YOUR PART NUMBER

### ROUND

3E								
<b>SERIES</b>	<b>MOUNTING</b>	<b>SHAPE AND SIZE</b>	<b>COLOR</b>	<b>OVERALL HEIGHT H</b>		<b>HEIGHT ABOVE RECESS A</b>		<b>TAPE</b>
	<b>TH</b> through-hole <b>SH</b> surface mount	<b>A</b> Ø5.2 mm <b>E</b> Ø7.8 mm <b>K</b> Ø11.6 mm	<b>60</b> blue <b>63</b> grey <b>64</b> yellow <b>68</b> red <b>69</b> black	<b>A</b> 10.4 <b>B</b> 11.0 <b>C</b> 12.0 <b>D</b> 12.5 <b>E</b> 13.0	<b>F</b> 14.0 <b>G</b> 15.0 <b>H</b> 16.0 <b>J</b> 19.0 <b>K</b> 22.5	<b>A</b> 2.4 <b>B</b> 3.0 <b>C</b> 3.5 <b>D</b> 4.0 <b>E</b> 4.5 <b>F</b> 5.0 <b>G</b> 5.6 <b>H</b> 6.4	<b>R</b> optional	

### SQUARE

3E								
<b>SERIES</b>	<b>MOUNTING</b>	<b>SHAPE AND SIZE</b>	<b>COLOR</b>	<b>OVERALL HEIGHT H</b>		<b>HEIGHT ABOVE RECESS A</b>		<b>TAPE</b>
	<b>TH</b> through-hole <b>SH</b> surface mount	<b>B</b> 5.2 mm <b>F</b> 7.8 mm <b>L</b> 11.6 mm	<b>60</b> blue <b>63</b> grey <b>64</b> yellow <b>68</b> red <b>69</b> black	<b>A</b> 10.4 <b>B</b> 11.0 <b>C</b> 12.0 <b>D</b> 12.5 <b>E</b> 13.0	<b>F</b> 14.0 <b>G</b> 15.0 <b>H</b> 16.0 <b>J</b> 19.0 <b>K</b> 22.5	<b>A</b> 2.4 <b>B</b> 3.0 <b>C</b> 3.5 <b>D</b> 4.0 <b>E</b> 4.5 <b>F</b> 5.0 <b>G</b> 5.6 <b>H</b> 6.4	<b>R</b> optional	

**NOTICE** : please note that not all combinations of above numbers are available. Refer to [www.apem.com](http://www.apem.com) for further information.



## MOUNTING

- Panel cut-out :  
5.2 mm : min. Ø5.6 / 5.6x5.6 mm  
7.8 mm : min. Ø8.2 / 8.2x8.2 mm  
11.6 mm : min Ø12.0 / 12.0x12.0mm
- Switch spacing AxB :  
5.2 & 7.8 mm : min. 12.7x12.7 mm  
Ø11.6 mm : min 13.6x13.6 mm  
11.6 mm : min. 12.7x12.7 mm



## MATERIALS

- Cap :  
- solid color : polyamide UL94V2



## STANDARD LEGENDS

STANDARD LEGENDS									
LEGEND	1D09_	1F096R_	1ZB09D_ / 1ZB16DLMH_	1ZC_	1Z_ / 1ZW_	10A_	10C_	10R_ & 10RF_ / 10RM16_	10Q_ / 10QM16_
0	000	000							
1	001	001							
2	002	002							
3	003	003							
4	004	004							
5	005	005							
6	006	006							
7	007	007							
8	008	008							
9	009	009							
#	107	107							
*	019	019							
←	033								
→	133								
↑	034								
↓	134								
↙	135	135							
+						054		054	054
-						059		059	059
▲			136		136	136			
⏻	123	123		123*	123		123	123	123
ON/OFF								017	017
STOP								018	018
START								031	031
RESET				038				038	038
CANCEL								048	048
ENTER								105	105
ESC				051					
ON						116			
OFF						117			
OK				118*	118		118	118	118
SET				119					
MENU				120					
FUNC				121					
HOME				122					

### STANDARD OPTIONS

- 1D: pad printed
- 1F: reverse printed
- 1ZB: pad printed / laser marked
- 1ZC: pad printed \*reverse printed \*laser marked
- 1Z & 1ZW: pad printed / laser marked

- 10A: pad printed / laser marked
- 10C: pad printed / laser marked
- 10RM & 10QM: metal symbol
- 10R(F) & 10Q: pad printed / reverse printed

# Legends

Available for Multimec caps



## HOW TO ORDER

### POSITIONING OF LEGENDS ON ROCKER-ACTION CAPS

When ordering legends for caps with hinge-type cap retention system, it is important to note the position of the cap. An extra letter (U, D, R or L) needs to be added to the part number to refer to the position of the hinges in relation to the legend. See samples:

Rocker-action caps without a lens: 1A, 1B, 1M, 1ZA and 1ZB

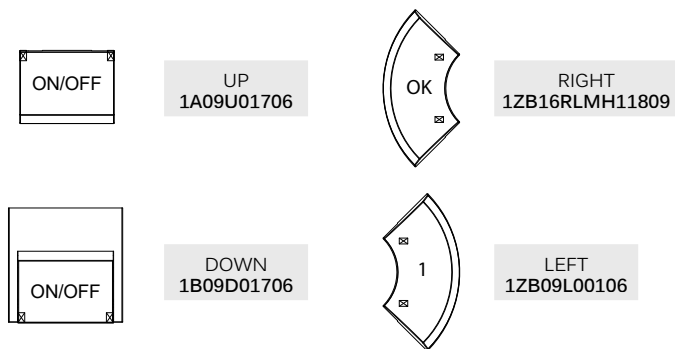

### STANDARD AND CUSTOM LEGENDS

- Standard are only certain legends on certain caps. See the table on the previous page.
- All standard pad-printed legends are white on black caps.
- All standard reverse-printed and laser marked legends are black on frosted white cap.

### LEGEND ILLUMINATION

- **Option 1 - laser marked:** In case of laser marked legends an "LM" is added after the cap colour, before the legend code. We recommend using hard paint (additional "H") for increased lifetime of the paint. E.g. 1ZB16DLMH13609
- **Option 2 - reverse printed:** In case of reverse printed caps an "R" is added after the cap colour, before the legend code. Especially relevant when standard legends have both negative and positive print options. E.g. 1FS096R00009
- **Option 3 - metal symbol:** Only available for 10RM and 10QM (therefore the "M"). E.g. 10RM16059

### ORIENTATION OF THE SWITCH

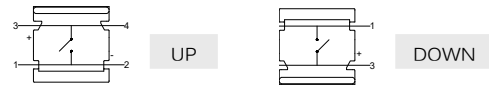

### STANDARD LEGENDS

CAP	CAP COLOR	DIRECTION*	TYPE*	LEGEND	LEGEND COLOR*
1B	00 Blue	D Down	LM Laser marked on soft paint	001 1	00 Blue
1DS	02 Green	U Up	LMH Laser marked on hard paint	002 2	02 Green
...	03 Grey	R Right	R Reverse printed	003 3	03 Grey
	04 Yellow	L Left		... etc	04 Yellow
	06 White	*Only for hinge-type caps			06 White
	08 Red		*In case of illumination		08 Red
	09 Black				09 Black
	16 Frosted white				... Etc
	...				

\*In case of reverse printed and laser marked legends the colour of the paint





















**Notice:** The size of the legends listed may not correspond to the actual size.

If you decide to use one of the standard legends without any adjustments (without a new cliché or programming) on another cap than designated in the table, then there is no cliché or programming cost, for this to apply the cap has to be black and the print white.

For further information on legends please contact your local distributor or MEC.

# Solid colors

Available for Multimec caps

Colour / RAL Code		Blue / 5012	green / 6018	Grey / 7004	Yellow / 1023	White / 9010	Red / 3000	Black / 9004	Ultra blue / 5002	Mint green / 6029	Tele grey / 7046	Melon / 1028	Signal white / 9003	Noble red / 3002	Dusty blue / 5014	Aqua blue / 5021	Metal dark blue / No ral code	Metal light grey / No ral code	Metal dark grey / No ral code	Metal bordeaux / No ral code
CAP	CODE	00	02	03	04	06	08	09	30	32	33	34	36	38	40	42	50	53	57	58
1A		•	•	•	•	•	•	•												
1B		•	•	•	•	•	•	•												
1D		•	•	•	•	•	•	•	•	•	•	•		•	•	•	•	•	•	•
1E/1F				•				•												
1GA/1GC								•												
1H				•				•												
1K		•	•	•	•	•	•	•												
1M			•	•			•	•												
1N				•				•												
1P		•	•	•	•	•	•	•												
1Q		•		•				•												
1R				•																
1S		•	•	•	•	•	•	•												
1T/1U/1V		•		•			•	•												
1WA/ 1WD				•				•												
1X				•		•		•												
1ZA				•		•		•	•						•	•	•	•	•	•
1ZB				•		•		•	•						•	•	•	•	•	•
1ZC				•		•	•	•	•						•	•	•	•	•	•
10A				•			•	•												
AQC								•												

The RAL Codes mentioned are the codes nearest to the solid colors in the multimec® range.

\*3E actuators and Varimec use different materials and therefore have a different color code and are not represented in this table

# Multimec® 3E

High performance tactile switches •  
robust



## DISTINCTIVE FEATURES

10 x 10 mm; h=6.4 mm

Variable height options with 3E actuators and Varimec caps



## ENVIRONMENTAL SPECIFICATIONS

- Sealing : IP67 according to IEC 60529
- Working and storage temperature :
  - non-illuminated : -40 °C/+160 °C
- Soldering :
  - through hole : IEC 68-2-20 8
  - surface mount : JEDEC J-STD-020E



## ELECTRICAL SPECIFICATIONS

- Recommended load :
  - Gold contacts : 0.5  $\mu$ -50 mA 24 VDC
  - Silver contacts : 0.5-50 mA 24 VDC
- Contact resistance : <30 m $\Omega$  - typically 10 m $\Omega$
- Insulation resistance : >10 M $\Omega$
- Contact bounce : <2 mS - typically 0.5 mS



## MECHANICAL SPECIFICATIONS

- Standard actuation force 3.5 N
- Max. actuation force : 100 N for 10 sec
- Travel : 1 mm
- Lifetime : >10,000,000 cycles

The company reserves the right to change specifications without notice.



## MATERIALS

- Housing : PPS UL94V0
- Actuator : PPS UL94V0
- Sealing : Silicone rubber
- Contacts spring : Stainless steel
  - Silver : +3  $\mu$ Ag
  - Gold : +1  $\mu$ Au
- Fixed contacts :
  - Silver : SnCu + 2  $\mu$ NI + 3  $\mu$ Ag
  - Gold : SnCu + 2  $\mu$ NI + 1  $\mu$ Au
- Terminals : SnCu + 2  $\mu$ NI + 3  $\mu$ Sn100

All tolerance if not otherwise specified  $\pm$ 0.2 mm.

# Multimec® 3E

High performance tactile switches • robust

## 3E - SMD

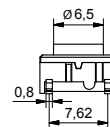
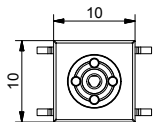

## 3E - TH

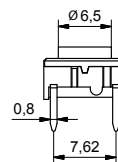
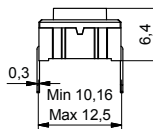
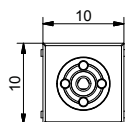

## 3E - RAS

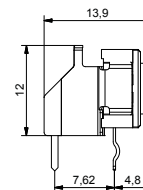
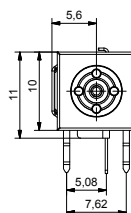
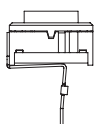

## PCB LAYOUT & CIRCUIT DIAGRAM

TH Non-ill.

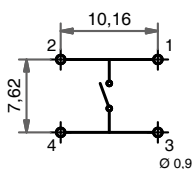

SMD non-ill.

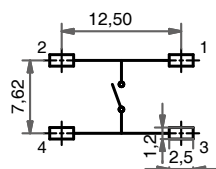

RAS

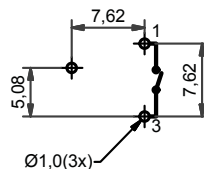

# Multimec<sup>®</sup> 3E

High performance tactile switches •  
robust



## BUILD YOUR PART NUMBER

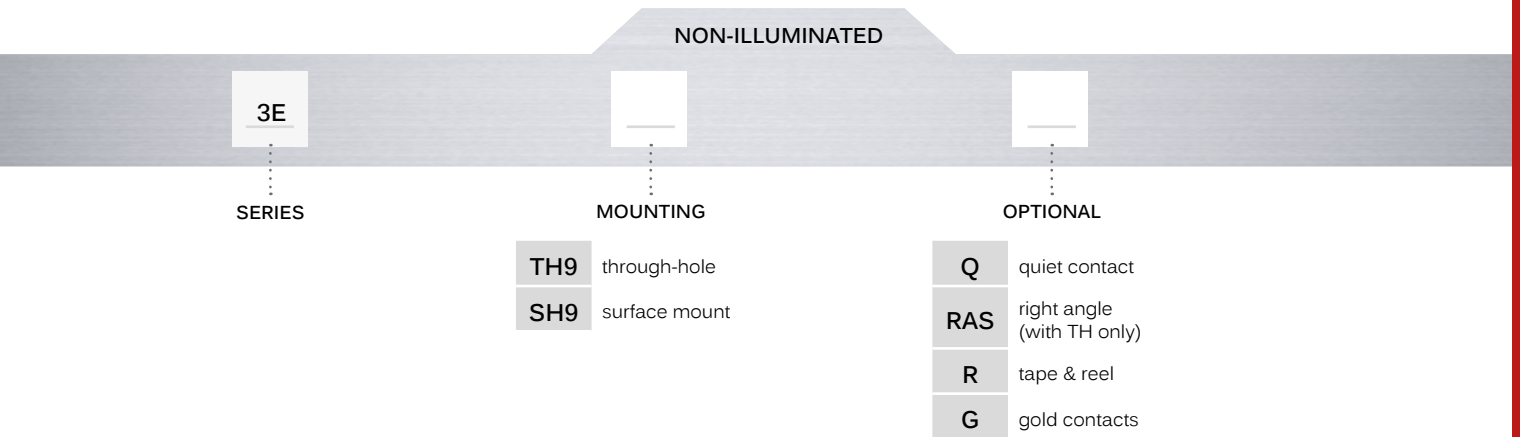

## ABOUT THIS SERIES



**Caps and accessories** : for the full range of accessories for Multimec 3E please see the website.



# Multimec® 3E

High performance tactile switches • robust



## TAPE & REEL

Tape and reel is available for the parts listed and has the following specifications

- Reel diameter: Ø330 mm
- Tape width: 24 mm
- Pitch: See list
- Tape and reel material : antistatic or better
- Quantity per reel : see list

PART NO.	ORDERING CODE	PITCH	QUANTITY PER REEL
3ESH9	3ESH9R	16	500
3ESH9-08.0	3ESH9R08.0	20	250
3ESH9-09.5	3ESH9R09.5	20	250
3ESH9-10.4	3ESH9R10.4	20	250
3ESH9-11.0	3ESH9R11.0	20	250
3ESH9-12.0	3ESH9R12.0	20	250
All Varimec below 12.5; R after the part no.		20	250



## OPERATING FORCE

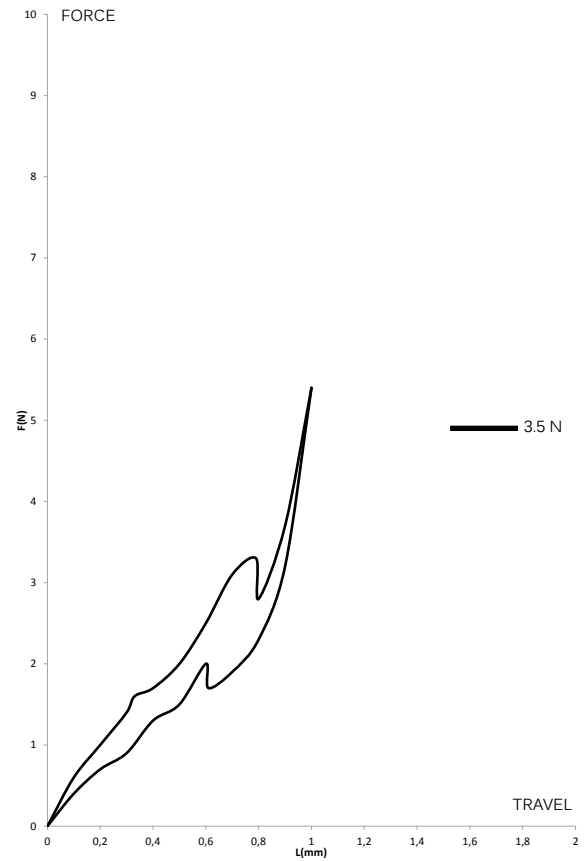

## MOUNTING

MOUNTING TOOLS FOR MULTIMEC® THROUGH-HOLE SWITCHES

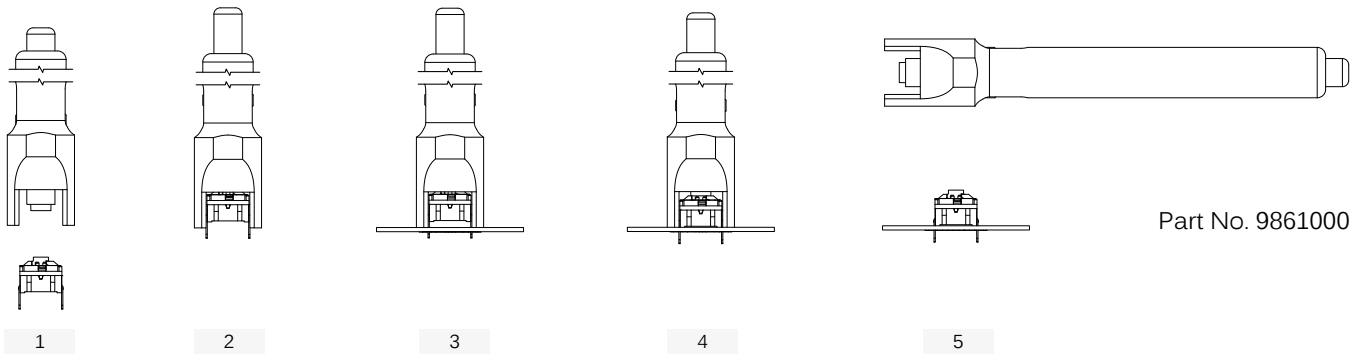



## MOUNTING (CONTINUED)

### SPACE REQUIREMENT - MATRIX MOUNTING

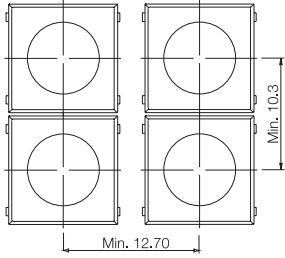

Through-hole (TH)

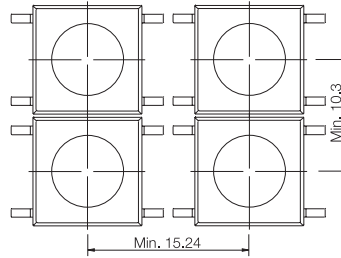

Surface mount (SMD)

### SPACE REQUIREMENT - SWITCH/CAP

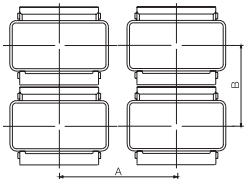

Switch spacing

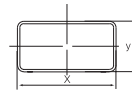

Cap dimensions

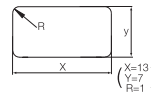

Panel cut-out

CAP SERIES	RECOMMENDED MIN. SWITCH SPACING AxB	NOMINAL CAP DIMENSION WxH	RECOMMENDED MIN. PANEL CUT-CUT
3E ACTUATORS	12.7x12.7	Ø6.5	Ø7.0
VARIMEC	12.7x12.7 12.7x12.7 12.7x12.7	Ø5.2 / 5.2 x 5.2 Ø7.8 / 7.8 x 7.8 Ø11.6 / 11.6 x 11.6	Ø5.6 / 5.6 x 5.6 Ø8.2 / 8.2 x 8.2 Ø12.0 / 12.0 x 12.0

# Multimec® 3E

High performance tactile switches •  
robust



## USAGE GUIDELINES

### HOW TO GET THE BEST RESULTS WITH MEC SWITCHES ?

These guidelines are offered to users of MEC Switches as an aid to ensure successful and reliable switch operation. Please see the technical specifications for details on operating and storage temperatures and soldering guidelines to make sure you select the best switch for your application. When wave soldering is taking place, MEC strongly recommend that the temperature profile is analyzed and compared with the temperature rating of the switch. It is also important to monitor the accumulated heat buildup from both the pre-heat zones and the solder zone.

Most standard accessories for multimec® 3 series switches are made from ABS plastic with a maximum operating temperature of 65 °C. It is strongly recommended that accessories are mounted after soldering of the switch. If this is not possible care must be taken not to overheat the accessories during the soldering process. The 3E actuators and Varimec caps are, however, made of high temperature materials and will meet the same temperature specifications as the switches. For accessories made from other plastic materials please see multimec® and unimec™ technical specifications.

### MOUNTING AND DISMOUNTING

If switches are to be mounted in rows it is essential that the recommendations regarding spacing are followed. PC board thickness should be 1.4 ±0.2 mm and terminal hole diameter should be 0.9 mm.

All multimec® caps and bezels are easily slid onto the switch modules and can be changed at a later time with the exception of the 3E caps. Once these caps are installed they are not designed to be removed. To do so may cause damage to the switch and the PC board if not done very carefully.

A mounting tool is available for through hole multimec® 3 series switches.

### SOLDERING AND CLEANING MULTIMEC® 3 SERIES

Multimec® 3 series switches are fully sealed to IP67 specifications to prevent solder flux and aqueous based cleaning solutions from entering the switch and contaminating the contacts. The switches can be placed on the PC board with other components and wave soldered. Multimec® 3 series offers a high level of sealing, however, with aqueous solvent solutions care must be taken to avoid the worst case situation with water jets, complete immersion into a liquid with a temperature below the board or surface tension reducing additives.

Recommended cleaning methods are demineralized water. Any surface tension reducing agents, such as soap, must not be used as they risk causing a potential leakage of the switch.

### SOLDERING - THROUGH HOLE VERSIONS

**Hand soldering:** max. 350 °C for max. 3 sec

**Wave soldering:** heat built up in the switch during pre-heating and soldering must not exceed the maximum operating temperature of the switch. Peak temperature must not exceed 260 °C, and soldering time is max 10 sec. (IEC 60068-2-20 8)

### SOLDERING - SURFACE MOUNT VERSIONS

For all methods - infrared, convection and vapor phase. The upper limit 240 °C/40 sec must be observed. The soldering temperature profile must have moderate temperature gradients. (JEDEC J-STD-020E)

### ROHS COMPLIANCE

As of 1 July 2006 MEC has completed the conversion to RoHS compliance. For more info please see our homepage [www.apem.com](http://www.apem.com)

### TEMPERATURE LIMITS:

Switch	160 °C
Accessories	65/85/160 °C

### PACKAGING

Multimec® 3 series switches are packed in rigid tubes of 50 pieces each.

A box contains 1.000 pcs.

The surface mount versions of multimec® 3 series switches with a height up to 12.5 mm can also be delivered on tape/reel.

Each reel contains 250/500 pcs.